

DESCRIPTION: 981 SERIES RIGHT ANGLE BACKSHELL

DIMENSIONS (IN.)						
No. OF PINS	A	B	C	D	E	F
9	1.265	1.850	0.628	1.312	0.610	0.625
15	1.580	2.314	0.639	1.305	0.995	0.620
25	2.143	2.870	0.633	1.305	1.528	0.606

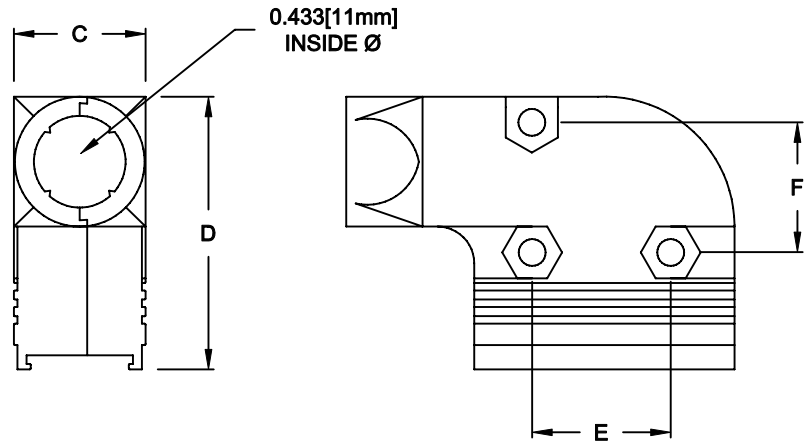
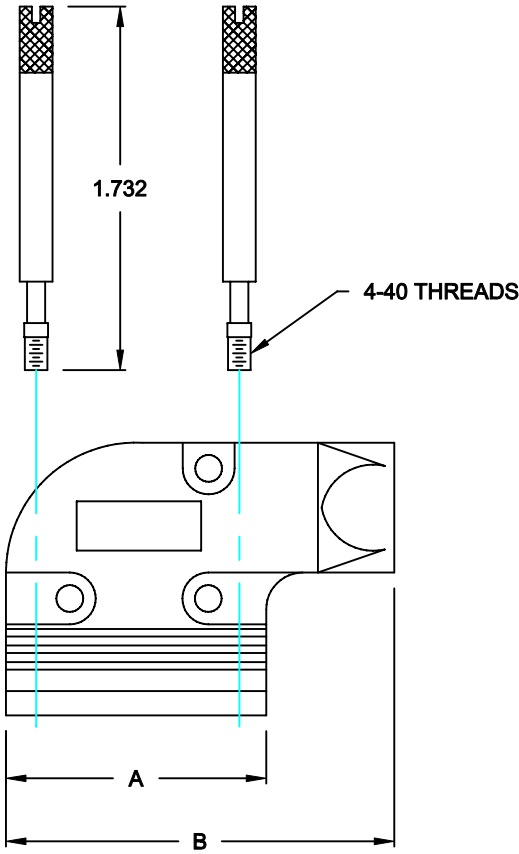

BACKSHELL KIT INCLUDES:

- (2) BACKSHELL HALVES
- (3) HOUSING SCREWS & NUTS
- (2) THUMBSCREWS
- (1) GROMMET TREE (NON-CONDUCTIVE)

981-YYY-130R121

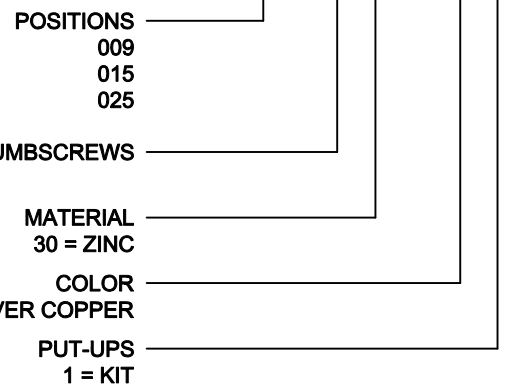

DO NOT SCALE FROM DRAWING

	THESE DRAWINGS AND SPECIFICATIONS ARE THE PROPERTY OF NorComp AND SHALL NOT BE REPRODUCED, COPIED OR USED AS THE BASIS FOR THE MANUFACTURE OF SALE OF APPARATUS WITHOUT WRITTEN PERMISSION.		DRAWN: C. SMITH	DATE: 02-16-07	
			CHECKED: X	DATE: X	
<h1>NorComp</h1>			SCALE: FULL	SHEET 1 OF 1	REV 0
			DWG NO. 981-YYY-130R121		

RoHS COMPLIANT